

ADEMCO

VISTA AT

SECURITY SYSTEM

VISTA CONSOLE

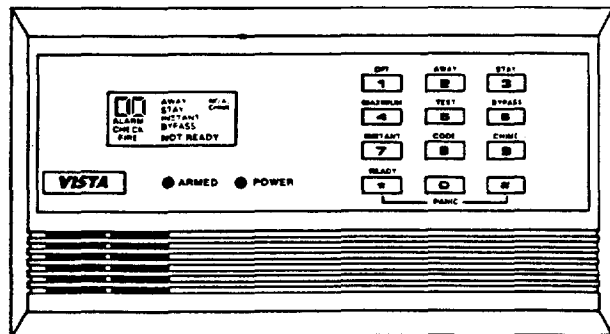

ALPHA VISTA CONSOLE

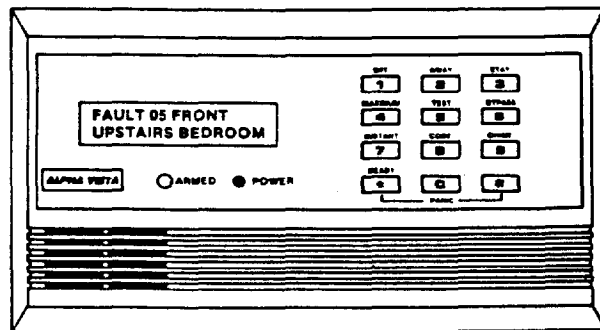

USER'S MANUAL

TABLE OF CONTENTS

INTRODUCTION	4
IDENTIFYING THE EQUIPMENT	6
SECTION 1. SECURITY SYSTEM WITH VISTA CONSOLE	
FUNCTIONS OF THE CONSOLE	8
CHECKING FOR OPEN ZONES	11
ARMING THE SYSTEM (WITH NO ONE REMAINING).....	12
DISARMING THE SYSTEM AND SILENCING ALARMS.....	13
ARMING THE SYSTEM (WHILE INSIDE, EXPECTING A LATE ARRIVAL)	14
ARMING THE SYSTEM (WHILE INSIDE, WITH NO EXPECTED LATE ARRIVALS	15
ARMING THE SYSTEM (WHILE INSIDE, WITH MAXIMUM SECURITY)	16
BYPASSING PROTECTION ZONES	17
DISPLAYING BYPASSED PROTECTION ZONES	18
TEMPORARY CODES.....	19
CHIME ANNUNCIATION	20
AMBUSH.....	21
PANIC	22
SUMMARY OF AUDIBLE NOTIFICATIONS	23
TROUBLE CONDITIONS	24

SECTION 2. SECURITY SYSTEM WITH ALPHA VISTA CONSOLE

FUNCTIONS OF THE CONSOLE	25
CHECKING FOR OPEN ZONES	27
ARMING THE SYSTEM (WITH NO ONE REMAINING)	28
DISARMING THE SYSTEM AND SILENCING ALARMS	29
ARMING THE SYSTEM (WHILE INSIDE, EXPECTING A LATE ARRIVAL)	30
ARMING THE SYSTEM (WHILE INSIDE, WITH NO EXPECTED LATE ARRIVALS)	31
ARMING THE SYSTEM (WHILE INSIDE, WITH MAXIMUM SECURITY)	32
BYPASSING PROTECTION ZONES	33
DISPLAYING BYPASSED PROTECTION ZONES	34
TEMPORARY CODES	35
CHIME ANNUNCIATION	36
AMBUSH	37
PANIC	38
SUMMARY OF AUDIBLE NOTIFICATIONS	39
TROUBLE CONDITIONS	40
VIEWING MESSAGES	40
SELF-HELP FEATURE	41

ALL SYSTEMS

PROTECTION ZONES	42
QUESTIONS AND ANSWERS ABOUT YOUR SECURITY SYSTEM	43
EMERGENCY PHONE NUMBERS	45
FCC STATEMENT	46
NATIONAL FIRE PROTECTION ASSN. RECOMMENDATIONS	47
EMERGENCY EVACUATION	48
OWNER'S INSURANCE PREMIUM CREDIT REQUEST FORM	49
DRAW YOUR OWN EVACUATION PLAN	51
THE LIMITATIONS OF THIS ALARM SYSTEM	52
WARRANTY	54

USER'S MANUAL

INTRODUCTION

Congratulations on your ownership of the VISTA AT security system. You've made a wise decision in choosing it, for it offers the best security protection available today.

Basically, this system offers you three forms of protection: burglary, fire and emergency. To realize the system's full potential, it is important that you feel comfortable in operating it.

This manual is a step-by-step guide that will fully acquaint you with the system's features and benefits. It defines the components and their functions, describes their operation, and acquaints you with normal and emergency procedures.

Your system consists of a Control mounted within a secured cabinet (generally in a concealed location in residential applications), at least one Console (VISTA or ALPHA

VISTA type)* which permits full control of system operation, various sensors which serve to provide perimeter and interior burglary protection, plus a selected number of strategically placed smoke or combustion detectors designed to provide early warning in the event of fire. The Console(s) will, in most cases, be remotely located for convenience; in some applications, a Console may be mounted on the front of the cabinet.

The Control within the cabinet is the "brains" of your system. It uses microcomputer technology to monitor all protection zones, analyzes the status of the system at all times and provides appropriate information for display on the Console(s) used in the system, and also initiates appropriate alarms when required.

*Up to 5 Consoles may be used in the system, in any combination.

ABOUT THIS MANUAL

This manual contains separate sections (Sections 1 and 2) covering the description of the operating functions of the two types of Consoles (Section 1 for VISTA Consoles, Section 2 for ALPHA VISTA Consoles). Refer to the appropriate section for each Console used in your system. Information

that applies to both types of Consoles (and to the system in general) has been excluded from Sections 1 and 2 and can therefore be considered applicable to the entire system, regardless of the type of Console(s) used.

GLOSSARY

The following glossary of terms used throughout the manual will avoid any confusion.

ARM/DISARM: "Armed" simply means that the burglary portion of your system is turned ON and is in a state of readiness. "Disarmed" means that the burglary system is turned OFF, and must be rearmed to become operational. However, even in a "disarmed" state, "emergency" and "fire" portions of your system will still be operational.

KEYPAD: This is the area on your Console containing numbered pushbuttons similar to those on telephones or calculators. These keys control the arming or disarming of the system, and perform other functions which will be described.

ZONE: A specific area of protection.

BYPASS: To disarm a specific area of burglary protection while leaving other areas operational.

DELAY ZONE: An area of protection containing doors most frequently used to enter or exit (typically, a front door, back door, or door from the garage into the house). The delay zone allows sufficient time for authorized entry and exit without causing an alarm. Consult your installer for the entry and exit delay times that have been set for your system during installation and record them on page 7.

DAY/NIGHT ZONE: An area of protection whose violation causes a trouble indication during the disarmed (DAY) mode and an alarm during the armed (NIGHT) mode.

IDENTIFYING THE EQUIPMENT

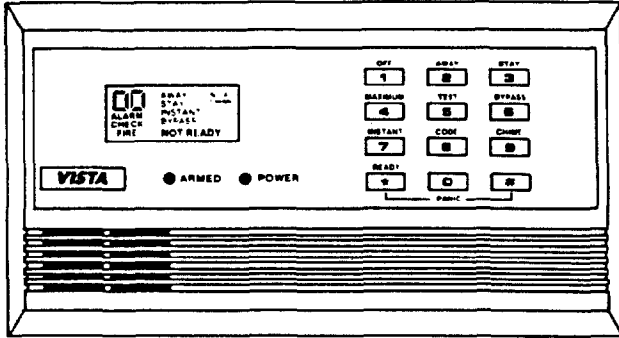

THE VISTA CONSOLE: enables you to control all system functions and also enables you to monitor and diagnose system operation. It is equipped with a multifunction 12-key digital keypad, a fixed-word English language/zone numeric LCD* and status indicator lights which can display the nature and location of all occurrences, plus a built-in alarm sounder.

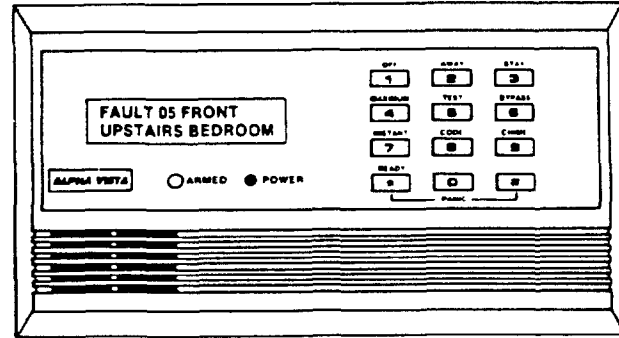

THE ALPHA VISTA CONSOLE: is similar to the VISTA Console, except that it is equipped with a 2-line, 32-character, fully programmable alphanumeric LCD* which can present the nature and location of all occurrences in an English language display (as depicted in the illustration above). A self-help feature is also incorporated. This feature is activated by simply pressing any of the function keys for 5 seconds. The message display screen on the Console will then scroll information related to the use of the key that has been pressed. This feature will prove particularly useful if this manual is not conveniently accessible when you need to perform a little-used system procedure with which you are not familiar.

*Liquid Crystal Display

DELAY ZONE ENTRY AND EXIT TIMES

These are set by your installer during installation and determine the number of seconds available for exit and entry through a delay zone, when arming and disarming the burglary protection, to avoid setting off an alarm.

The delay times for your system should be recorded here:

Exit Delay #1 _____ seconds* **Entry Delay #1** _____ seconds**
Exit Delay #2 _____ seconds* **Entry Delay #2** _____ seconds**

*May be from 15 to 225 seconds, but no more than 60 seconds for a UL Listed Household burglary application.

**May be from 15 to 225 seconds, but no more than 45 seconds for a UL Listed Household burglary application.

FUNCTIONS OF THE CONSOLE

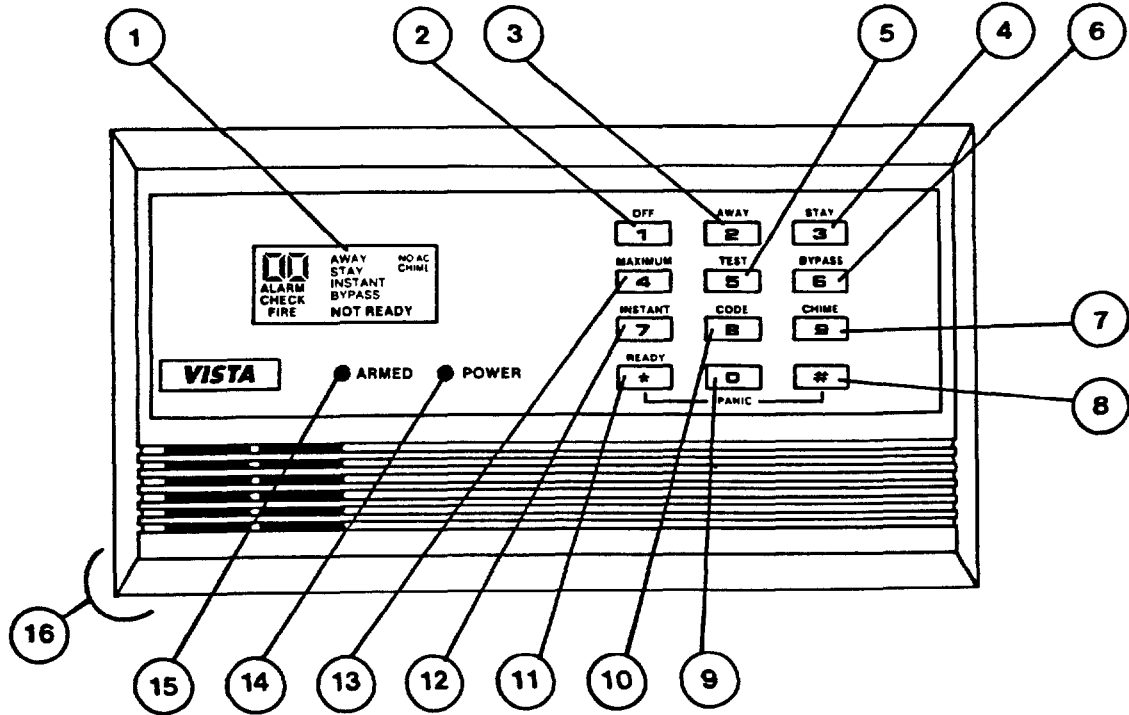

1. **LCD (Liquid Crystal Display) WINDOW:** Combined protection zone identification display (2-digit) and system status display:

2-Digit Numeric Display: Identifies protection zones, Nos. **01-17**. Also may display **99** (panic). May also display **95** and/or **96** for additional emergency conditions, depending on programming by installer. Lastly, it can display **97** for an expansion zone (zones 10-17) supervisory problem.

System Status Display:

AWAY: When all burglary zones are armed.

STAY: When all burglary zones, except the interior zones, are armed.

INSTANT: When entry delay is disabled.

BYPASS: When one or more burglary protection zones have been bypassed.

NOT READY: When burglary portion of the system is not ready for arming (due to open burglary or emergency protection zones).

READY: When the burglary portion of the system is ready to be armed.

NO AC: When AC power has been cut off.

AC: When AC power is present.

CHIME: When CHIME feature is activated (see 7).

ALARM: When an intrusion has been detected and the system is armed (also appears during a Fire alarm). Accompanied by a display (above) of the protection zone in alarm.

CHECK: When a malfunction is discovered in the system at any time or if a fault is detected in a FIRE zone at any time or in a DAY/NIGHT burglary zone during a disarmed period. Accompanied by a display of zone number in trouble.

FIRE: When a fire alarm is present. Accompanied by a display of the zone in alarm.

2. **OFF KEY:** Disarms the burglary portion of the system, silences alarms, and clears visual alarm and trouble indications after the problem has been corrected. (SECURITY CODE + OFF).
3. **AWAY KEY:** Completely arms the burglary portion of the system. (SECURITY CODE + AWAY).
4. **STAY KEY:** Arms the burglary portion of the system with the exception of the interior zones of protection. (SECURITY CODE + STAY).
5. **TEST KEY:** Tests the system and the alarm sounder during the disarmed mode. (SECURITY CODE + TEST).
6. **BYPASS KEY:** Removes individual protection zones from being monitored by the system. (SECURITY CODE + BYPASS + NN, where NN** is the number of the protection zone being removed). Displays previously bypassed protection zones. (SECURITY CODE + BYPASS).

*Single-digit numbers must be preceded by a 0.

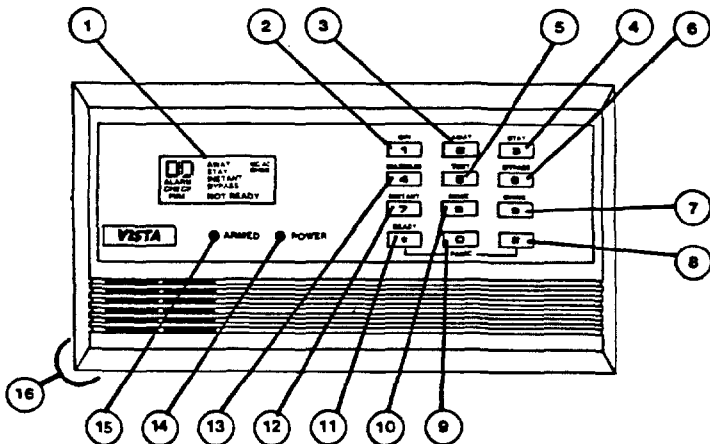

- 7. **CHIME KEY:** Turns on the CHIME mode so that any entry through a delay or perimeter zone during the disarmed period causes 3 tones to sound at the Console. (SECURITY CODE + CHIME). To turn CHIME mode off, repeat sequence (CODE + CHIME).
- 8. **# KEY:** Permits ARMING of the system without use of a security code ("Quick Arm", if programmed to do so at installation time). Press # + AWAY, STAY, etc.

- 9. **KEYS 0-9** are used to enter your individual security access code(s).
- 10. **CODE KEY:** Allows the entry of new temporary access codes that can be given to users of the system. [MASTER SECURITY CODE + CODE key + NN + TEMPORARY SECURITY CODE, where: NN = user numbers 03 through 15 or 04 through 14 (depending upon installation configuration)].
- 11. **READY KEY:** When depressed prior to arming the system, the console will display all open protection zones.
- 12. **INSTANT KEY:** Arms the burglary portion of the system with the exception of the interior zones of protection and removes entry delay period (CODE + INSTANT).
- 13. **MAXIMUM KEY:** Completely arms the burglary portion of the system and removes entry delay period (CODE + MAXIMUM).
- 14. **POWER INDICATOR:** (GREEN) Lit when power is on.
- 15. **ARMED INDICATOR:** (RED) Lit when the system has been armed (STAY, AWAY, INSTANT or MAXIMUM).
- 16. **INTERNAL SOUNDER:** Source of audible internal warning and confirmation sounds, as well as alarms (see "Summary of Audible Notification").
- 8 & 11. *** and # KEYS:** Submits a **PANIC** alarm (silent or audible emergency or fire, as installer-programmed) when simultaneously depressed.

*Other pairs of keys may also have been programmed for panic alarms (See **PANIC** Section).

CHECKING FOR OPEN ZONES

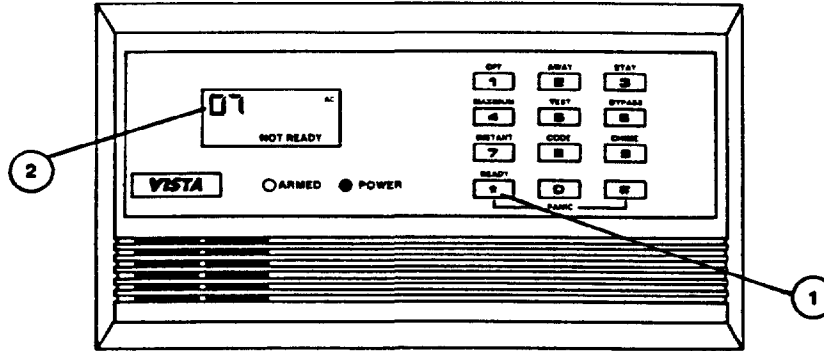

BEFORE ARMING YOUR ALARM SYSTEM, ALL PROTECTED DOORS, WINDOWS AND OTHER PROTECTION ZONES MUST BE CLOSED.

- 1.** Prior to arming, if **NOT READY** is displayed, check for open zones by depressing the **READY** key.
- 2.** All open protection zones will be displayed.
- 3.** **READY** will be displayed when all protection zones have been made intact or corrected.

ARMING THE SYSTEM

(WITH NO ONE REMAINING)

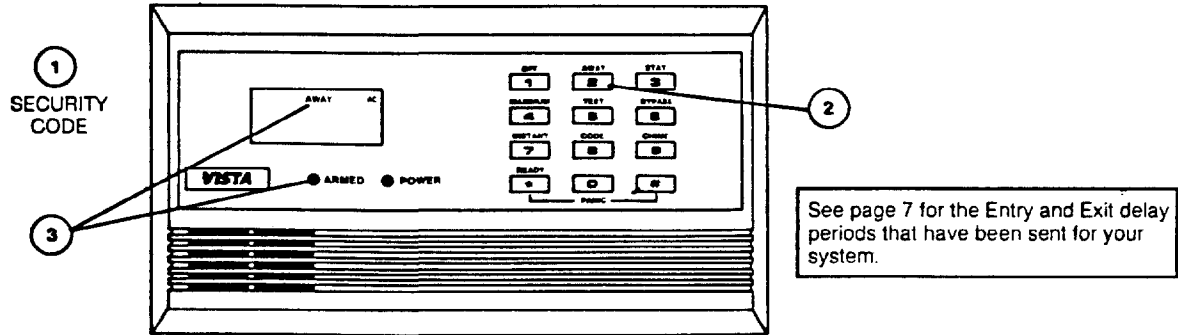

See page 7 for the Entry and Exit delay periods that have been sent for your system.

PROCEDURE:

1. With **READY** displayed, enter the security code (or “#” if “Quick Arm” is used).
2. Press the **AWAY** key.
3. The **ARMED** indicator will light and **AWAY** will be displayed. The console will beep twice. Exit delay begins. Perimeter protection is in effect immediately.

- You will be able to exit within the exit delay period.
- After the exit delay period has expired, an alarm will occur if entry occurs through a door in the delay zone and the system is not turned off in time.
- All protection zones are armed and will sound alarms immediately when violated (except those with entry / exit delay, which will sound alarms when the delay period has expired).

DISARMING THE SYSTEM AND SILENCING ALARMS

(FOR AWAY, STAY, INSTANT, AND MAXIMUM ARMING)

PROCEDURE:

1. Enter security code.
2. Press **OFF**. If an alarm has occurred, note the numbers displayed and repeat procedure to restore the **READY** display. If **READY** will not display, go to the displayed protection zone and remedy the fault (close windows, etc.). If the fault cannot be remedied, notify the alarm agency.

RESULT:

- Any alarm sounders will be silenced; **ALARM** and zone identification number (if displayed) will go off only when the open sensor is closed.
- A fire alarm is indicated by a display of both **FIRE** and **ALARM** on the console. These will go out only when the fire zone is again intact.

①
SECURITY
CODE

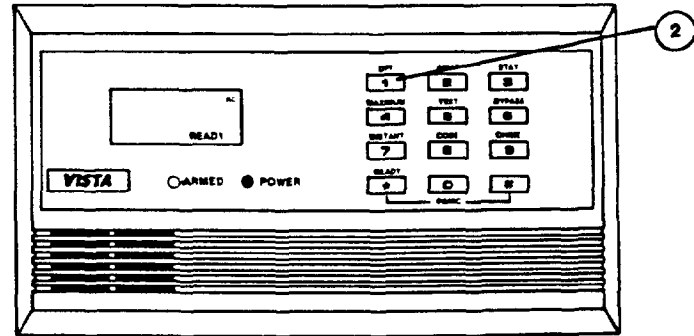

See "Summary of Audible Notification" on page 23 for information which will enable you to distinguish between FIRE and BURGLARY alarm sounds.

ARMING THE SYSTEM

(WHILE INSIDE, EXPECTING A LATE ARRIVAL)

SECURITY CODE ①

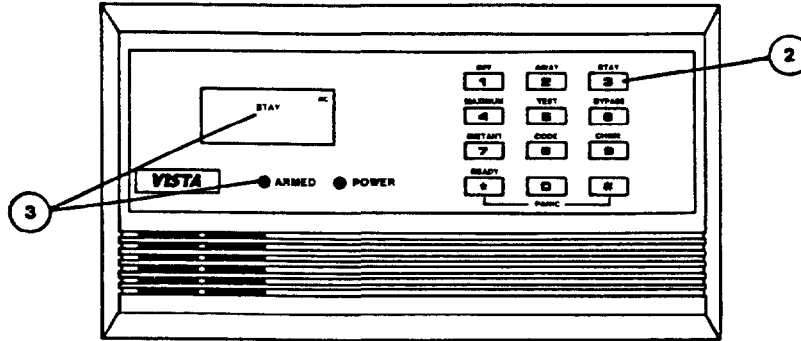

PROCEDURE:

1. With **READY** displayed, enter the security code (or "#" if "Quick Arm" is used).
2. Press the **STAY** key.
3. **ARMED** indicator will light and **STAY** will be displayed. The console will beep three times. Exit delay begins.

RESULT:

- All perimeter protection zones are armed and will sound alarms immediately when violated. (Except those with entry/exit delay, which will sound alarms when the delay period has expired).
- All interior protection zones are disarmed to permit freedom of movement throughout the interior.
- The person arriving later will be able to enter without causing an alarm, but must disarm the system before the entry delay expires.

ARMING THE SYSTEM

(WHILE INSIDE, WITH NO EXPECTED LATE ARRIVALS)

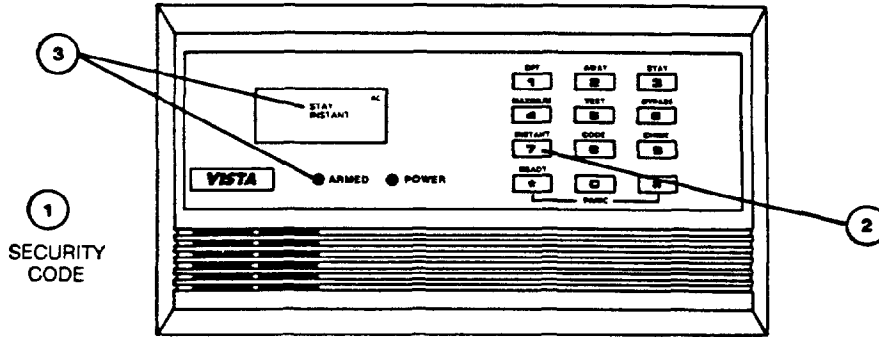

PROCEDURE:

1. With **READY** displayed, enter the security code (or "#" if "Quick Arm" is used).
2. Press the **INSTANT** key.
3. The **ARMED** indicator will light and **STAY** and **INSTANT** will be displayed. The console will beep three times.

RESULT:

- All interior protection zones are disarmed for freedom of movement throughout the interior.
- All perimeter protection zones, including those with delays, are armed (after exit delay) and will **instantly** cause an alarm when violated.

ARMING THE SYSTEM

(WHILE INSIDE, WITH MAXIMUM SECURITY)

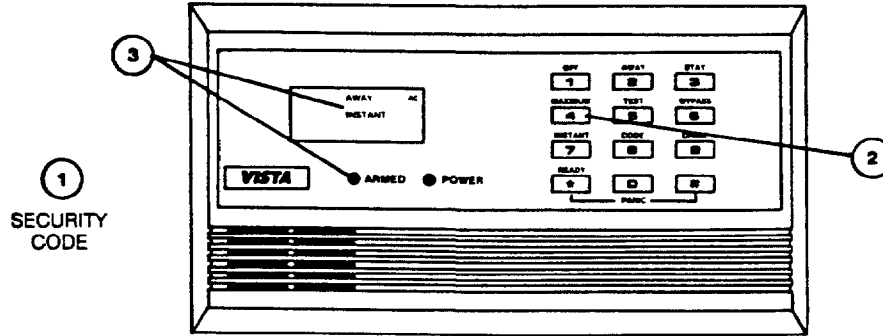

PROCEDURE:

1. With **READY** displayed, enter the security code (or “#” if “Quick Arm” is used).
2. Press the **MAXIMUM** key.
3. The **ARMED** indicator will light and **AWAY** and **INSTANT** will be displayed (the console will also beep twice).

RESULT:

- All protection zones (perimeter and interior), including those with delays, are armed (after exit delay) and will **instantly** cause an alarm when violated.

BYPASSING PROTECTION ZONES

(USED FOR ARMING SYSTEM WITH ONE OR MORE ZONES SELECTIVELY LEFT UNPROTECTED)

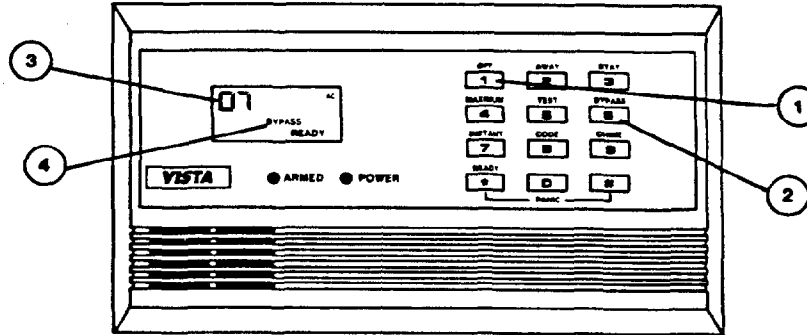

PROCEDURE:

1. System must be disarmed first.
2. Enter security code + **BYPASS** + zone number(s) (e.g., 01, 02, 03, etc.). **Important!** All single digit zone numbers **must** be preceded by a zero (example enter **01** and not **1**).
3. Wait for all bypassed protection zones to be sequentially displayed (each accompanied by one beep) before arming.
4. **BYPASS** will be displayed to indicate the presence of one or more bypassed zones.
5. Arm system.

RESULT:

- All bypassed protection zones will **not** cause an alarm when violated.

LIMITATIONS:

- The system must first be placed in the disarmed state to perform the bypass procedure.
- Fire or emergency zones **cannot** be bypassed.
- Arming the system before bypassed zones are displayed nullifies the bypass procedure.

NOTE: All bypasses are removed when an OFF sequence (security code plus OFF) is performed.

DISPLAYING BYPASSED PROTECTION ZONES

(USED FOR DETERMINING WHAT PROTECTION ZONES HAVE BEEN BYPASSED)

PROCEDURE:

1. If **BYPASS** is displayed, enter security code + **BYPASS**.
2. Wait for all bypassed protection zones to be sequentially displayed (each accompanied by one beep).

NOTE: The system must be in the disarmed mode when this display function is performed.

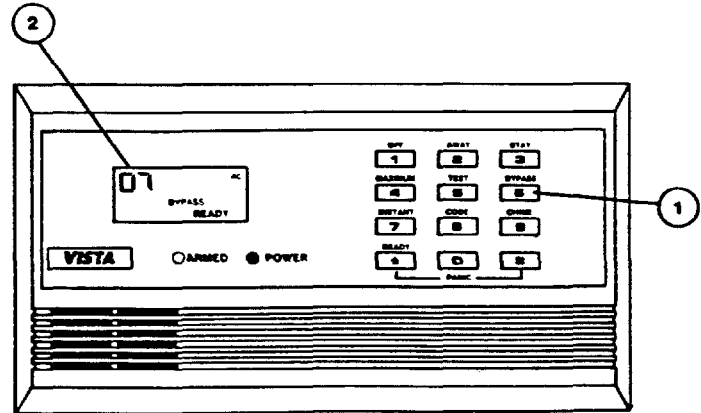

TEMPORARY CODES

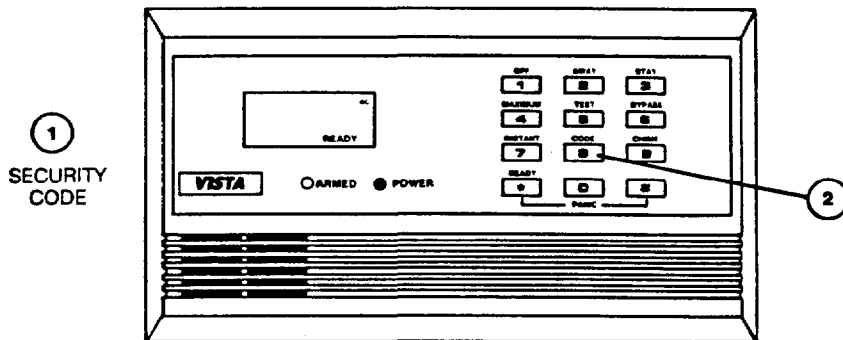

PROCEDURE:

1. Enter master security code.
2. Press **CODE** + user number (03-15)* + the temporary security code. The console will beep once when the has been completed successfully.

*Some installations will only accommodate 04-14.

CAUTIONS:

- Up to thirteen (or eleven, depending on configuration) separate temporary codes may be assigned.
- Do not assign a temporary code that conflicts with the AMBUSH code (see **AMBUSH** section).
- To remove a temporary code, enter master security code + **CODE** key + user number (to be deleted) + security code.
- Users to whom temporary codes have been assigned should not be shown how to bypass protection zones unless they have a need to know.

CHIME ANNUNCIATION

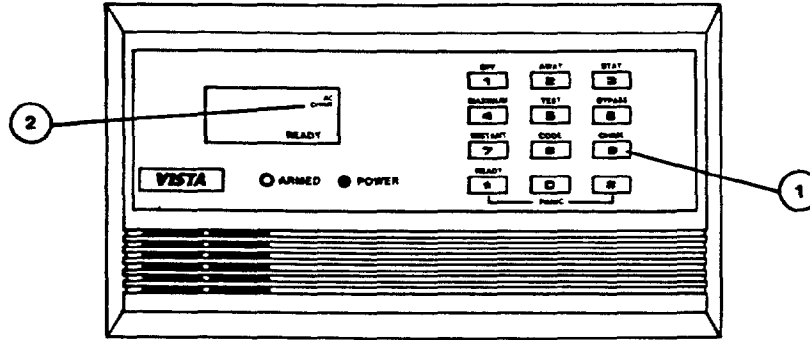

PROCEDURE:

THIS FEATURE IS FUNCTIONAL ONLY WHEN THE BURGLARY SYSTEM IS DISARMED.

1. Enter security code and depress the **CHIME** key.
2. **CHIME** will be displayed.

RESULT:

- When a door in the delay zone is opened, or a perimeter zone is disturbed (e.g., window opened), **NOT READY** will be displayed and three tones will be heard at the console.

NOTE: The chime mode is turned off by entry of the security code and depression of **CHIME** again.

AMBUSH

[WHEN FORCED TO DISARM (OR ARM) SYSTEM UNDER THREAT]

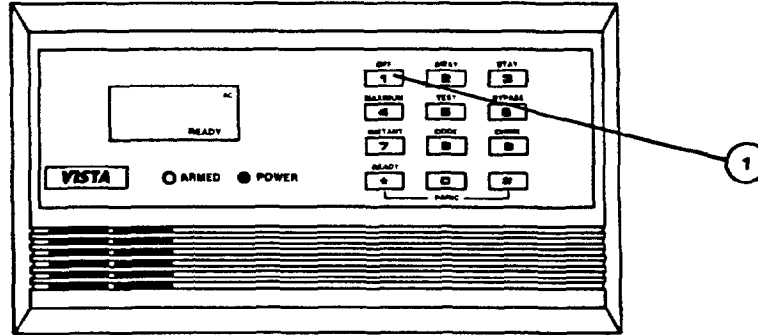

PROCEDURE:

1. Enter the first three digits of the security code.
Increase the final digit by one and then press **OFF** (or **AWAY**, etc.).

EXAMPLE:

(Normal Security Code) **1 2 3 4 + OFF**
(Ambush Security Code) **1 2 3 5 + OFF**

RESULT



- The system will disarm, but the system can silently notify the central station of your situation, if you have that service.

IMPORTANT:

- This function is useful only when connected to a central station.
- Ambush code capability is not present for any code ending in 9.
- Users of temporary codes must be instructed to enter their codes carefully to avoid the possibility of accidentally entering the ambush code.

PANIC

One of the following symbols may appear next to each set of active emergency keys:

-  PERSONAL EMERGENCY
-  FIRE
-  POLICE

PROCEDURE:

1. Press * and # keys simultaneously*.

*Key 1 and * and/or keys 3 and # may also have been programmed for silent or audible emergency alarm at the time of installation (see below).

Emergency Keys:

Your installer should have indicated below any functions that have been programmed into the available pairs of Emergency Keys. Typical functions that might be programmed are Silent Police, Audible Police, Personal Emergency and Fire.

KEYS	FUNCTION	NUMERIC DISPLAY**
* and #	_____	99
1 and *	_____	95
3 and #	_____	96

**Only if audible emergency programmed.

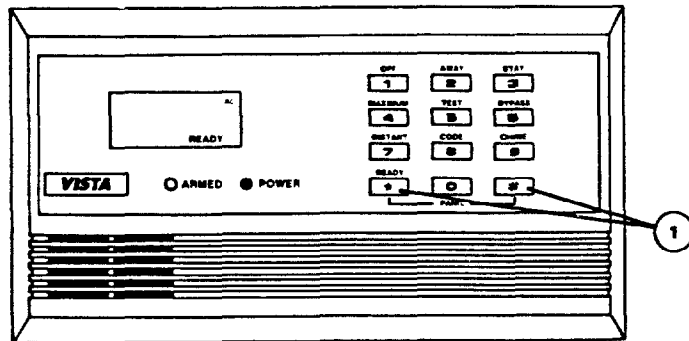

RESULT

If programmed for **silent emergency** by your installer and the system is connected to a central alarm monitoring station, a silent alarm signal will be sent. There will be no audible alarms or visual displays in this case.

If programmed for **audible emergency** by your installer, a loud alarm will sound at your console and at any external sounders that may be connected [**ALARM** (or **ALARM** and **FIRE**), plus **95**, **96** or **99** would also be displayed for **1** and *****, **3** and **#**, or ***** and **#** respectively].

SUMMARY OF AUDIBLE NOTIFICATIONS

AT CONSOLE	EXTERNAL (If Used)	CAUSE	DISPLAY
LOUD, INTERRUPTED ALARM SOUND*	SAME	FIRE ALARM	• FIRE and ALARM is displayed; protection zone in alarm is displayed.
LOUD, CONTINUOUS ALARM SOUND*	SAME	BURGLARY/AUDIBLE EMERGENCY ALARM	• ALARM is displayed; protection zone in alarm is also displayed.
ONE SHORT BEEP (not repeated)	NONE	a. SYSTEM DISARM	• Only READY is displayed.
		b. SYSTEM ARMING ATTEMPT WITH AN OPEN ZONE	• NOT READY is displayed, open protection zone number is displayed.
		c. BYPASS VERIFY	• The bypass protection zone numbers are displayed. (One beep for each number displayed). BYPASS displayed.
TWO SHORT BEEPS	NONE	ARM AWAY OR MAXIMUM	• AWAY and possibly INSTANT are displayed.
THREE SHORT BEEPS	NONE	a. ARM STAY OR INSTANT	• STAY and possibly INSTANT are displayed.
		b. ZONE OPENED WHILE SYSTEM IS IN CHIME MODE	• CHIME displayed, NOT READY is displayed
RAPID BEEPING	NONE	a. TROUBLE	• CHECK displayed. Troubled protection zone is displayed.
		b. AC POWER LOSS ALERT**	• NO AC displayed.
		c. MEMORY OF ALARM	• FIRE and/or ALARM is displayed; protection zone in alarm is displayed
SLOW BEEPING	NONE	ENTRY DELAY WARNING	• None during delay; exceeding the delay time without disarming causes alarm.

* If bell is used as external sounder, fire alarm is **pulsed ring**; burglary/audible emergency is **steady ring**.

** Loss of battery power is not indicated or annunciated by the console (warnings are provided for loss of AC power only).

TROUBLE CONDITIONS

If the word **CHECK** appears on the Console's display accompanied by a rapid "beeping" at the Console, it indicates that there is a trouble condition in the system.

Typical Trouble Displays:

1. A display of **CHECK** accompanied by a numeric display of **97** indicates that a problem exists with the system that eliminates some of the protection. **CALL FOR SERVICE IMMEDIATELY.** Press any key to silence the audible warning sound.
2. A display of **CHECK** accompanied by a numeric display of one or more zone numbers indicates that a problem exists with those zone(s). First, determine if the zone(s) displayed are intact and make them so if they are not. Press any key to silence the audible warning sound. If the problem has been corrected, the display of the zone number(s) and **CHECK** will be erased. If the display persists, **CALL FOR SERVICE IMMEDIATELY.**

If **"FC"** appears in the numeric display area, a failure has occurred in the telephone communication portion of your system. **CALL FOR SERVICE IMMEDIATELY.**

FUNCTIONS OF THE CONSOLE

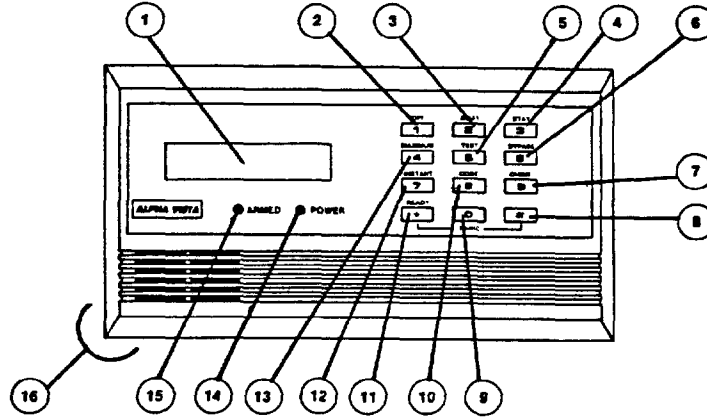

1. **DISPLAY WINDOW:** A 2-line, 32-character Liquid Crystal Display (LCD). Displays protection zone identification, system status, messages, and user instructions.
2. **OFF KEY:** Disarms the burglary portion of the system, silences alarms, and clears visual alarm, after the problem has been corrected. (SECURITY CODE + OFF).

3. **AWAY KEY:** Completely arms the burglary portion of the system. (SECURITY CODE + AWAY).
4. **STAY KEY:** Arms the burglary portion of the system with the exception of the interior zone of protection. (SECURITY CODE + STAY).
5. **TEST KEY:** Tests the system and the alarm sounder during the disarmed mode. (SECURITY CODE + TEST).

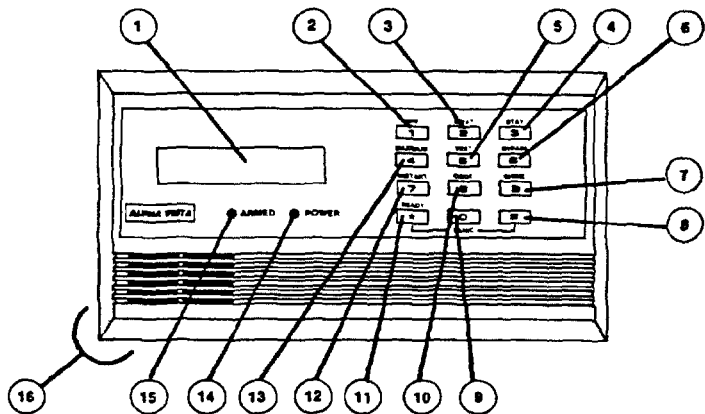

6. **BYPASS KEY:** Removes individual protection zones from being monitored by the system. (SECURITY CODE + BYPASS + NN, where NN* is the number of the protection zone being removed). Displays previously bypassed protection zones. (SECURITY CODE + BYPASS).
7. **CHIME KEY:** Turns on the CHIME mode so that any entry through a delay or perimeter zone during the disarmed period causes 3 tones to sound at the Console. (SECURITY CODE + CHIME). To turn CHIME mode off, repeat sequence (CODE + CHIME).
8. **# KEY:** Permits ARMING of the system without use of a security code ("Quick Arm", if programmed to do so at installation time). Press # + AWAY, STAY, etc.

9. **KEYS 0-9:** Used to enter your individual 4-digit security access code(s).
10. **CODE KEY:** Allows the entry of new temporary access codes that can be given to users of the system. (MASTER SECURITY CODE + CODE key + NN + TEMPORARY SECURITY CODE, where: NN = user numbers 03 through 15 or 04 through 14, depending upon installation configuration).
11. **READY KEY:** When depressed prior to arming the system, the console will display all open protection zones.
12. **INSTANT KEY:** Arms the burglary portion of the system with the exception of the interior zones of protection and removes entry delay period. (SECURITY CODE + INSTANT).
13. **MAXIMUM KEY:** Completely arms the burglary portion of the system and removes entry delay period. (SECURITY CODE + MAXIMUM).
14. **POWER INDICATOR:** (GREEN) Lit when power is on.
15. **ARMED INDICATOR:** (RED) Lit when the system has been armed (AWAY, STAY, INSTANT or MAXIMUM).
16. **INTERNAL SOUNDER:** Source of audible internal warning and confirmation sounds, as well as alarms (see "Summary of Audible Notification").
- 8 & 11. *** AND # KEYS*:** Submits a **PANIC** alarm (silent or audible emergency or audible fire, as installer-programmed) when simultaneously depressed.

*Other pairs of keys may also have been programmed for panic alarms (see **PANIC** section.)

CHECKING FOR OPEN ZONES

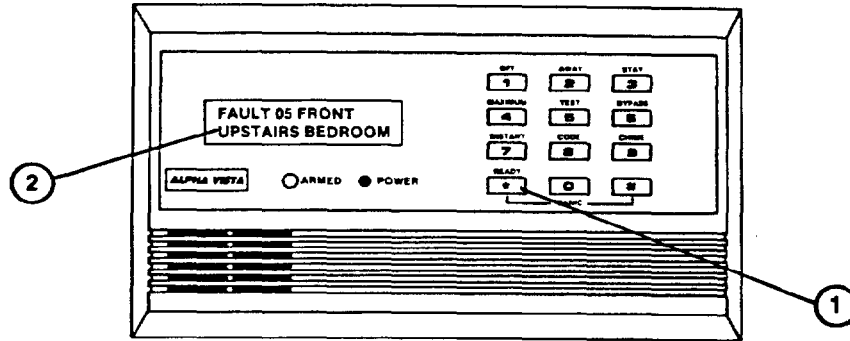

BEFORE ARMING YOUR ALARM SYSTEM, ALL PROTECTED DOORS, WINDOWS AND OTHER PROTECTION ZONES MUST BE CLOSED.

1. If the following display is present prior to arming, check for open zones by depressing the **READY** key.

**DISARMED - Press
* to show faults**

2. All open protection zones will be displayed.
3. The following will be displayed when all protection zones have been made intact or corrected.

******DISARMED****
READY TO ARM**

NOTE: All or part of the above message may be displaced by an alternative customized message programmed by the installer. Bear this in mind whenever the instructions in this section of the manual indicate that the "Disarmed" message above will be displayed.

ARMING THE SYSTEM

(WITH NO ONE REMAINING)

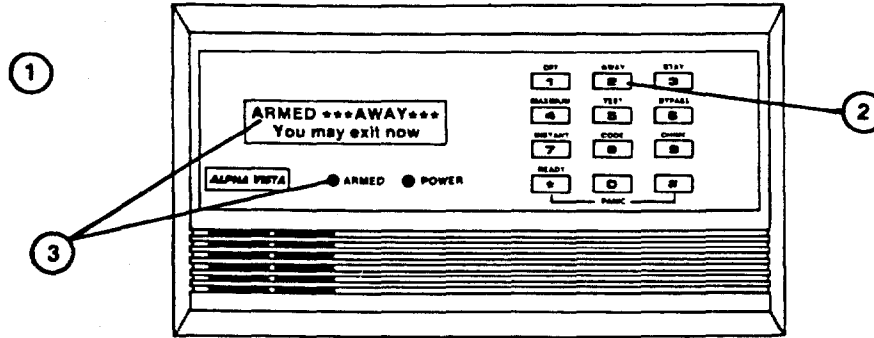

See page 7 for the Entry and Exit delay periods that have been set for your system.

PROCEDURE:

1. The following must be displayed before arming can be attempted.

******DISARMED****
READY TO ARM**

Then enter the security code (or "#" if "Quick Arm" is used).

2. Press the **AWAY** key.

3. **ARMED ***AWAY***
You may exit now**

will be displayed. The console will beep twice. Exit delay begins. Perimeter protection is in effect immediately.

RESULT:

- You will be able to exit within the exit delay period.
- After the exit delay period has expired, an alarm will occur if entry occurs through a door in the delay zone and the system is not turned off in time.
- All protection zones are armed and will sound alarms immediately when violated (except those with entry/exit delay, which will sound alarms when the delay period has expired).

DISARMING THE SYSTEM AND SILENCING ALARMS

(FOR AWAY, STAY, INSTANT, AND MAXIMUM ARMING)

PROCEDURE:

1. Enter security code.
2. Press **OFF**. If an alarm has occurred, note the zone descriptor displayed and repeat procedure to restore the following display:

****DISARMED****
READY TO ARM

If the above will not display, go to the displayed protection zone and remedy the fault (close windows, etc.). If the fault cannot be remedied, notify the alarm agency.

RESULT:

- Any alarm sounders will be silenced; **ALARM** and zone descriptor will go off only when the open sensor is closed.
- A fire alarm is indicated by a display of **FIRE** and the zone descriptor on the console. These will go out only when the fire zone is again intact.

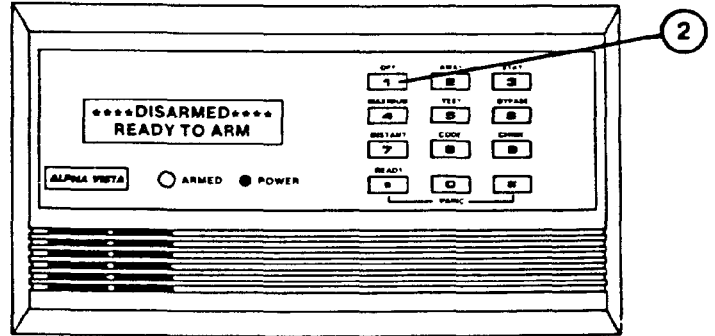

1

SECURITY
CODE

See "Summary of Audible Notification" on page 39 for information which will enable you to distinguish between FIRE and BURGLARY alarm sounds.

ARMING THE SYSTEM

(WHILE INSIDE, EXPECTING A LATE ARRIVAL)

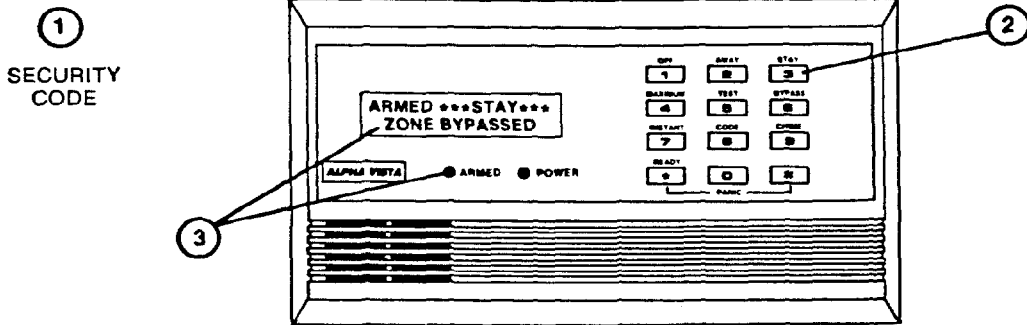

PROCEDURE:

1. The following must be displayed before arming can be attempted.

******DISARMED******
READY TO ARM

Then enter the security code (or “#” if Quick Arm” is used).

2. Press the **STAY** key.
- 3.

ARMED *STAY*****
ZONE BYPASSED

will be displayed. The console will beep three times. Exit delay begins.

RESULT:

- All perimeter protection zones are armed and will sound alarms immediately when violated. (Except those with entry/exit delay, which will sound alarms when the delay period has expired).
- All interior protection zones are disarmed to permit freedom of movement throughout the interior.
- The person arriving later will be able to enter without causing an alarm, but must disarm the system before the entry delay expires.

ARMING THE SYSTEM

(WHILE INSIDE, WITH NO EXPECTED LATE ARRIVALS)

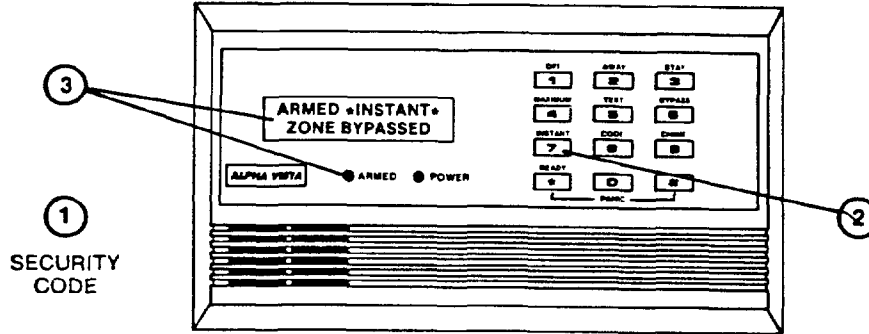

PROCEDURE:

1. The following must be displayed before arming can be attempted.

****DISARMED****
READY TO ARM

Then enter the security code (or "*" if "Quick Arm" is used).

2. Press the **INSTANT** key.

3. **ARMED *INSTANT* ZONE BYPASSED** will be displayed. The console will beep three times.

RESULT:

- All interior protection zones are disarmed for freedom of movement throughout the interior.
- All perimeter protection zones, including those with delays, are armed (after exit delay) and will **instantly** cause an alarm when violated.

ARMING THE SYSTEM

(WHILE INSIDE, WITH MAXIMUM SECURITY)

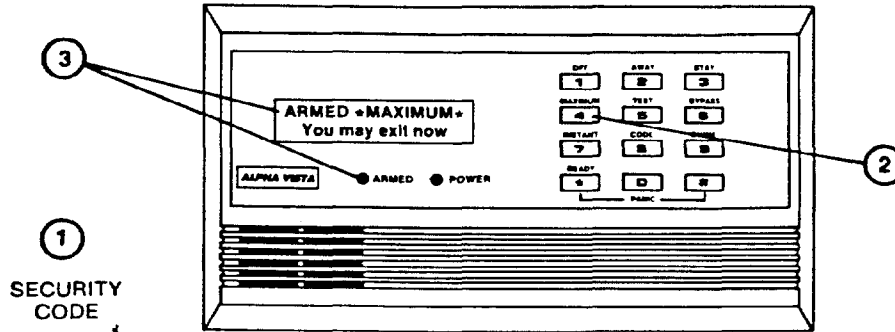

PROCEDURE:

1. The following must be displayed before arming can be attempted.

******DISARMED******
READY TO ARM

Then enter the security code (or "#" if "Quick Arm" is used).

2. Press the **MAXIMUM** key.

3. **ARMED *MAXIMUM*** will be displayed. The console will beep twice.

ARMED *MAXIMUM*
You may exit now

RESULT:

- All protection zones (perimeter and interior), including those with delays, are armed (after exit delay) and will **instantly** cause an alarm when violated.

BYPASSING PROTECTION ZONES

(USED FOR ARMING SYSTEM WITH ONE OR MORE ZONES SELECTIVELY LEFT UNPROTECTED)

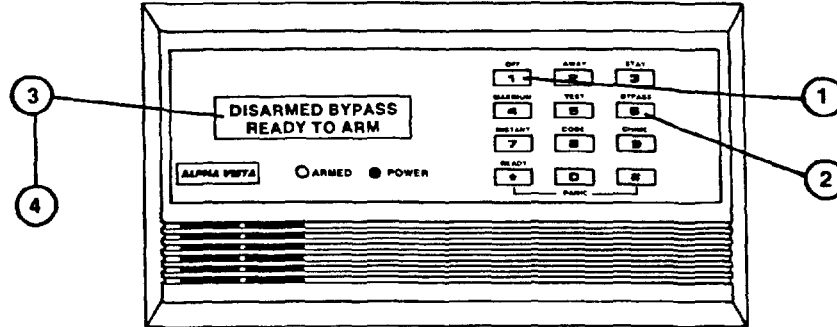

PROCEDURE:

1. System must be disarmed first.
2. Enter security code + **BYPASS** + zone number(s) (e.g., 01, 02, 03, etc.). **Important!** All single digit zone numbers **must** be preceded by a zero (example: enter **01** and not **1**).
3. Wait for all bypassed protection zones to be sequentially displayed (each accompanied by one beep) before arming.
4. **DISARMED BYPASS READY TO ARM** will be displayed to indicate the presence of one or more bypassed zones.
5. Arm system.

RESULT:

- All bypassed protection zones will **not** cause an alarm when violated.

LIMITATIONS:

- The system must first be placed in the disarmed state to perform the bypass procedure.
- Fire or emergency zones **cannot** be bypassed.
- Arming the system before bypassed zones are displayed nullifies the bypass procedure.

NOTE: All bypasses are removed when an OFF sequence (security code plus OFF) is performed.

DISPLAYING BYPASSED PROTECTION ZONES

(USED FOR DETERMINING WHAT PROTECTION ZONES HAVE BEEN BYPASSED)

PROCEDURE:

1. The following should be present if zones have been bypassed.

**DISARMED BYPASS
READY TO ARM**

To display the bypassed zones, enter security code + **BYPASS**.

2. Wait for all bypassed protection zones to be sequentially displayed (each accompanied by one beep).

IMPORTANT:

The system must be in the disarmed mode when this display function is performed.

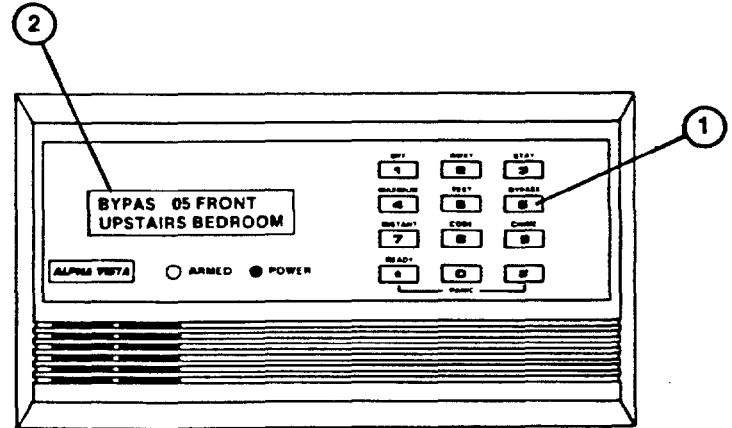

TEMPORARY CODES

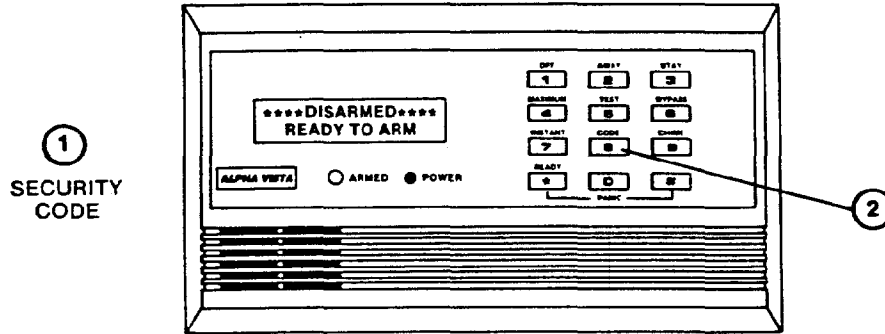

PROCEDURE:

1. Enter master security code.
2. Press **CODE** + user number (03-15)* + the temporary security code. The console will beep once when the procedure has been completed successfully.

*Some installations will only accommodate 04-14.

CAUTIONS:

- Up to thirteen (or eleven, depending on configuration) separate temporary codes may be assigned.
- Do not assign a temporary code that conflicts with the ambush code (see **AMBUSH** section).
- To remove a temporary code, enter master security code + **CODE** key + user number (to be deleted) + main security code.
- Users to whom temporary codes have been assigned should not be shown how to bypass protection zones unless they have a need to know.

CHIME ANNUNCIATION

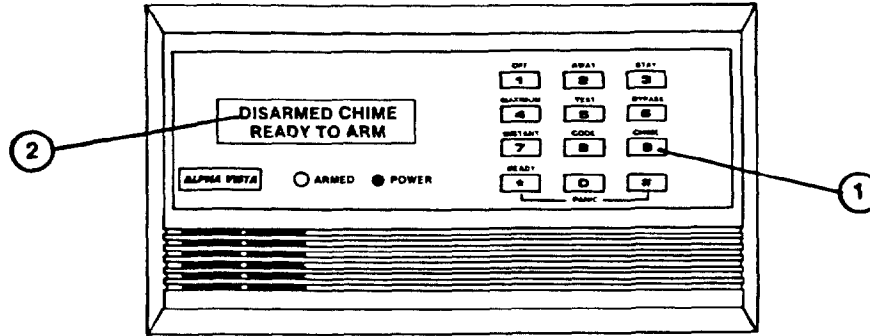

PROCEDURE:

THIS FEATURE IS FUNCTIONAL ONLY WHEN THE BURGLARY SYSTEM IS DISARMED.

1. Enter security code and depress the **CHIME** key.
2. **DISARMED CHIME READY TO ARM** will be displayed.

**DISARMED CHIME
READY TO ARM**

RESULT:

- When a door in the delay zone is opened or a perimeter zone is disturbed (e.g., window opened), the message "Press * Key" will appear and three tones will be heard at the console (pressing the * key will display the faulted zone).

NOTE: The chime mode is turned off by entry of the security code and depression of **CHIME** again.

AMBUSH

[WHEN FORCED TO DISARM (OR ARM) SYSTEM UNDER THREAT]

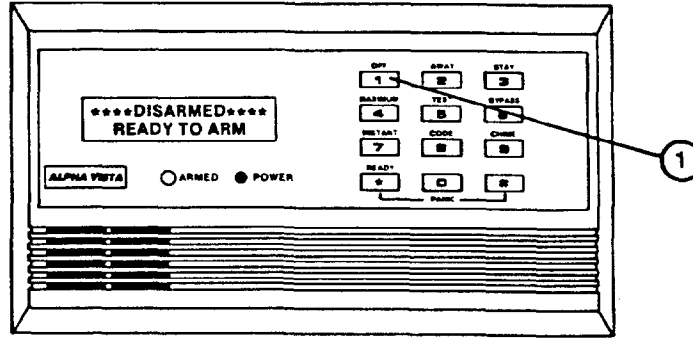

PROCEDURE:

1. Enter the first three digits of the security code.
Increase the final digit by one and then press **OFF** (or AWAY, etc.).

EXAMPLE:

(Normal Security Code) **1 2 3 4 + OFF**
(Ambush Security Code) **1 2 3 5 + OFF**

RESULT

- The system will disarm, but the system can silently notify the central station of your situation, if you have that service.

IMPORTANT:

- This function is useful only when connected to a central station.
- Ambush code capability is not present for any code ending in 9.
- Users of temporary codes must be instructed to enter their codes carefully to avoid the possibility of accidentally entering the ambush code.

PANIC

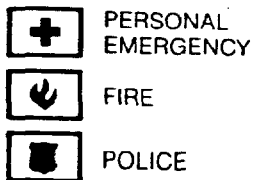

One of the following symbols may appear next to each set of active emergency keys:

PROCEDURE:

1. Press ***** and **#** keys simultaneously*.

* Keys **1** and ***** and/or keys **3** and **#** may also have been programmed for silent or audible emergency alarm at the time of installation (see below).

Emergency Keys: Your installer should have indicated below any functions that have been programmed into the available pairs of Emergency Keys. Typical functions that might be programmed are Silent Police, Audible Police, Personal Emergency, and Fire.

KEYS	FUNCTION	DISPLAY*
* and #	_____	_____
1 and *	_____	_____
3 and #	_____	_____

*Only if Audible Emergency programmed.

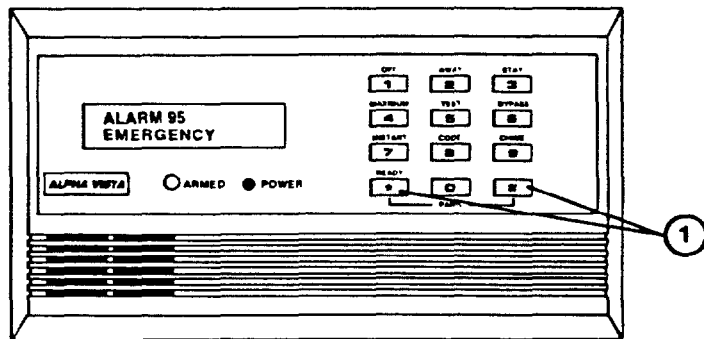

RESULT

If programmed for **silent emergency** by your installer and the system is connected to a central alarm monitoring station, a silent alarm signal will be sent. There will be no audible alarms or visual displays in this case.

If programmed for **audible emergency** by your installer, a loud alarm will sound at your console and at any external sounders that may be connected [**ALARM** (or **FIRE**) plus a description would also be displayed for **1** and *****, **3** and **#**, or ***** and **#** respectively].

SUMMARY OF AUDIBLE NOTIFICATIONS

AT CONSOLE	EXTERNAL (If Used)	CAUSE	DISPLAY
LOUD, INTERRUPTED ALARM	SAME SOUND*	FIRE ALARM	• FIRE is displayed; number and descriptor of zone in alarm is displayed.
LOUD, CONTINUOUS ALARM	SAME SOUND*	BURGLARY/AUDIBLE EMERGENCY ALARM	• ALARM is displayed; number and descriptor of zone in alarm is also displayed.
ONE SHORT BEEP (not repeated)	NONE	a. SYSTEM DISARM	• DISARMED/READY TO ARM is displayed.
		b. SYSTEM ARMING ATTEMPT WITH AN OPEN ZONE	• The number and descriptor of open protection zone is displayed.
		c. BYPASS VERIFY	• Numbers and descriptors of the bypassed protection zones are displayed (one beep is heard for each zone displayed. Subsequently, the following is displayed: DISARMED BYPASS Ready to arm
TWO SHORT BEEPS	NONE	ARM AWAY OR MAXIMUM	• ARMED AWAY or ARMED MAXIMUM is displayed. Red ARMED indicator is lit.
THREE SHORT BEEPS	NONE	a. ARM STAY OR INSTANT	• ARMED STAY or ARMED INSTANT is displayed. Red ARMED indicator is lit.
		b. ZONE OPENED WHILE SYSTEM IS IN CHIME MODE	• CHIME displayed, descriptor of open protection zone will be displayed if * key is pressed.
RAPID BEEPING	NONE	a. TROUBLE	• CHECK displayed. Number and descriptor of problem protection zone is displayed.
		b. AC POWER LOSS ALERT**	• AC LOSS displayed (may alternate with other displays that may be present).
		c. MEMORY OF ALARM	• FIRE or ALARM is displayed; number and descriptor of zone in alarm is displayed.
SLOW BEEPING	NONE	ENTRY DELAY WARNING	• DISARM SYSTEM or alarm will occur is displayed. Exceeding the delay time without disarming causes alarm.

* If bell is used as external sounder, fire alarm is **pulsed ring**; burglary/audible emergency is **steady ring**.

** Loss of battery power is not indicated or annunciated by the console (warnings are provided for loss of AC power only).

TROUBLE CONDITIONS

If the word **CHECK** appears on the Console's display accompanied by a rapid "beeping" at the Console, it indicates that there is a condition in the system that should be checked.

Typical Check Displays:

1. A display of **CHECK** accompanied by a display of **CALL SERVICE** indicates that a problem exists with the system that eliminates some of the protection. **CALL FOR SERVICE IMMEDIATELY.** Press any key to silence the audible warning sound.
2. A display of **CHECK** accompanied by a display of one or more zone descriptors indicates that a problem exists with those zone(s). First, determine if the zone(s) displayed are intact and make them so if they are not. Press any key to silence the audible warning sound. If the problem has been corrected, the display of the zone descriptor(s) and **CHECK** will be erased. If the display persists, **CALL FOR SERVICE IMMEDIATELY.**
3. A display of **"COMM. FAILURE"** indicates that a failure has occurred in the telephone communication portion of your system. **CALL FOR SERVICE IMMEDIATELY.**

VIEWING MESSAGES

Users of the system may periodically receive messages on their display screens from their monitoring agency. When a message is waiting to be viewed, the following display will appear:

**Message: Press 0
for 5 secs**

When the **"0"** key is pressed and held for 5 seconds, the message transmitted to you will appear on your display screen. The message could take up to four screens of information to be displayed for you to read it all.

SELF-HELP FEATURE

Abbreviated user's instructions are built into the system that can be easily viewed on the console's message display screen. This self-help feature will prove particularly useful if this manual is not conveniently accessible when you need to perform a little-used system procedure with which you are not familiar.

Eleven separate functions are covered by the built-in instructions. Each description is viewed by pressing the function key of interest until the description starts to appear (5 seconds) and then releasing it. The function keys and their functions are:

- OFF:** For turning off burglary protection or silencing audible troubles and alarms.
- AWAY:** For turning on all burglary protection when leaving.
- STAY:** For turning on perimeter burglary protection when staying.
- MAXIMUM:** For turning on all burglary protection with no entry delay when staying.
- INSTANT:** For turning on perimeter burglary protection with no entry delay when staying.
- TEST:** For testing the system.
- BYPASS:** For bypassing zones of protection.
- CODE:** For adding and deleting user security codes.
- CHIME:** For turning on and off the chime announcement mode.
- READY:** For determining specific faulted zones.
- #:** For use when "Quick Arming" without a security code.

PROTECTION ZONES

One or more sensing devices will have been assigned by the installer of your alarm system to each of the various protection zones in your system (although not every zone may have been used). For example, the sensing device on your Entry/Exit door may have been assigned to zone 01, sensing devices on windows in the master bedroom to zone 02, and so on. For your convenience, a chart has been provided below which may be used to record the specific protection points that have been assigned to each zone in your system. Your installer will assist you in recording this information.

ZONE	PROTECTION POINT(S)
01	_____
02	_____
03	_____
04	_____
05	_____
06	_____
07	_____
08	_____
09	_____
10	_____
11	_____
12	_____
13	_____

ZONE	PROTECTION POINT(S)
14	_____
15	_____
16	_____
17	_____

Other numeric displays may appear on your Console, as follows:

DISPLAY	MEANING
95	_____
96	_____

DISPLAY	MEANING
97	_____
99	_____

QUESTIONS AND ANSWERS ABOUT YOUR SECURITY SYSTEM

Q. I'm in. My system is armed. I accidentally set off the burglary alarm. What should I do?

A. Go to your Console. Enter your **security code** and press **OFF**. This will silence the alarm sounder. If your alarm is connected to a police department or alarm monitoring service, you have successfully sent a "cancel" signal to them. Telephone them immediately to advise that the alarm was accidental.

Q. I have an employee. I want that person to arm the system when they leave, but have no ongoing control over it. What should I do?

A. Enter a temporary security code at the Console and instruct your employee in its use. The temporary code can be changed when its usefulness is over.

Q. Cooking smoke has inadvertently triggered my fire alarm. What should I do?

A. At the Console, enter your **security code** and press the **OFF** key. This will silence the alarm. Should the **FIRE** display persist, check the smoke detectors in the affected area. Clear any residual smoke in the detector's chamber by fanning it for 30 seconds. Enter the security code and press the **OFF** key. If your system is connected to a fire department or alarm monitoring service, immediately advise them it's a false alarm.

Q. How does the system help me avoid false alarms?

A. A built-in fail-safe feature prevents you from arming the system while any of its sensors are not intact. Unarmed, no false alarms can occur. Also, an optional 16-second delay in the communication of burglary messages to your alarm monitoring service allows you to shut off any false burglary alarms caused by you before any messages are sent.

Q. I become aware of the presence of an intruder. What should I do?

A. Push your Emergency button (if installed) or simultaneously press both the * and # keys* on your Console. If your system is connected to an alarm monitoring station and has been programmed for silent emergency, a silent alarm signal will be sent. If your system has been programmed for audible emergency, a loud alarm will sound from your Console (and external sounders, if used).

* Other pairs of keys also may have been programmed by your installer for emergency alarms (See Panic Section).

Q. I return and my burglary alarm is sounding or my alarm memory display is present. What should I do?

A. Do not enter. Go to the nearest phone and call the police.

Q. What should I do if I hear my fire alarm?

A. Following your pre-arranged Emergency Evacuation Plan, help all occupants safely escape, then contact the Fire Department from a safe location.

Q. I incur an emergency and need help.

A. Press your Emergency button (if available) or simultaneously press the emergency keys* on your Console. If your system is connected to an alarm monitoring station and has been programmed for auxiliary alarm by your installer, an alarm signal will be sent and a loud, steady alarm will sound at your Console to alert other people on the premises.

Q. I'm In and want both intrusion protection and freedom of movement in the interior of my place.

A. At the Console, enter the **security code** and then press the **STAY** key. On either type of Console, the **ARMED** indicator will light and three beeps will be emitted. On the VISTA Console, **STAY** will be displayed; on the ALPHA VISTA Console, **ARMED STAY** will be displayed. The perimeter is now protected.

Q. I'm In and want an instantaneous alarm to be sounded if an intruder attempts to break in via my primary access door(s).

A. At the Console, enter your **security code** and press the **INSTANT** key. On either type of Console, the **ARMED** indicator will light and three beeps will be emitted. On the VISTA Console, **STAY** and **INSTANT** will be displayed; on the ALPHA VISTA Console, **ARMED INSTANT** will be displayed. Your system is armed and the Entry Delay period has been cancelled.

Q. The POWER indicator on my Console is off. What should I do?

A. If the POWER indicator is off, operating power for the Console has been cut off and the Console is therefore inoperative. **CALL FOR SERVICE IMMEDIATELY.**

However, if the POWER indicator is on, but **NO AC** (VISTA Console) or **AC LOSS** (ALPHA VISTA Console) is being displayed, AC power to the system has been cut off, and the system is operating from its back-up battery. You should therefore check the following:

1. If only some lights are out on the premises, check circuit breakers and fuses and reset or replace as necessary.
2. Check to see that your system's plug-in transformer has not been accidentally pulled out.
3. If these steps do not restore AC power to the system, call your service representative immediately.

*See PANIC section.

EMERGENCY PHONE NUMBERS

Alarm Monitoring Station _____

Fire Department _____

Police _____

Gas/Electric Company _____

Neighbor _____

Doctor _____

Hospital _____

Ambulance _____

Emergency _____

SERVICING INFORMATION:

Your local Ademco dealer is the person best qualified to service your alarm system. Arranging some kind of regular service program with him is advisable. Your local Ademco dealer is:

"FEDERAL COMMUNICATIONS COMMISSION (FCC) STATEMENT"

This equipment has been tested to FCC requirements and has been found acceptable for use. The FCC requires the following statement for your information:

This equipment generates and uses radio frequency energy and if not installed and used properly, that is, in strict accordance with the manufacturer's instructions may cause interference to radio and television reception. It has been type tested and found to comply with the limits for a Class B computing device in accordance with the specifications in Subpart J of Part 15 of FCC Rules, which are designed to provide reasonable protection against such interference in a residential installation. However, there is no guarantee that interference will not occur in a particular installation. If this equipment does cause interference to radio or television reception, which can be determined by turning the equipment off and on, the user is encouraged to try to correct the interference by one or more of the following measures:

- If using an indoor antenna, have a quality outdoor antenna installed.
- Reorient the receiving antenna until interference is reduced or eliminated
- Move the receiver away from the control/communicator.
- Move the antenna leads away from any wire runs to the control/communicator.
- Plug the control/communicator into a different outlet so that it and the receiver are on different branch circuits.

If necessary, the user should consult the dealer or an experienced radio/television technician for additional suggestions.

The user may find the following booklet prepared by the Federal Communications Commission helpful:

"How to Identify and Resolve Radio-TV Interference Problems."

This booklet is available from the U.S. Government Printing Office, Washington, DC 20402. Stock No. 004-000-00345-4.

IN THE EVENT OF TELEPHONE OPERATIONAL PROBLEMS

In the event of telephone operational problems, disconnect the control/communicator by removing the plug from the RJ31X/RJ32X jack. We recommend your certified installer demonstrate disconnecting the phones on installation of the system. Do not disconnect the phone connection inside the control/communicator. Doing so will result in the loss of your phone lines. If your regular phone works correctly after the control/communicator has been disconnected from the phone lines, the control/communicator

has a problem and should be returned for repair.

If upon disconnection of the control/communicator, there is still a problem on your line, notify the telephone company that they have a problem and request prompt repair service. The user may not under any circumstances (in or out of warranty) attempt any service or repairs on the system. It must be returned to the factory or an authorized service agency for all repairs.

NATIONAL FIRE PROTECTION ASSN. RECOMMENDATIONS ON SMOKE DETECTORS

With regard to the number and placement of smoke/heat detectors, we subscribe to the recommendations contained in the National Fire Protection Association's Standard #74 noted below:

Early warning fire detection is best achieved by the installation of fire detection equipment in all rooms and areas of the household as follows: A smoke detector installed outside of each separate sleeping area in the immediate vicinity of bedrooms and on each additional story of the family living unit including basements and excluding crawl spaces and unfinished attics. In addition, it is recommended that the householder consider the use

of heat or smoke detectors in the living room, dining room, bedroom(s), kitchen, hallway(s), attic, furnace room, utility and storage rooms, basements and attached garages.

NOTE: "Approval of the panel's burglar alarm functions does not fall within the (California) State Fire Marshal's area of jurisdiction."

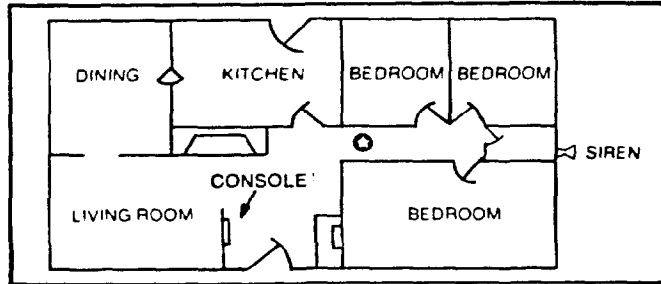

BEST RESIDENTIAL DETECTOR PLACEMENT
BETWEEN BEDROOMS AND REST OF HOUSE

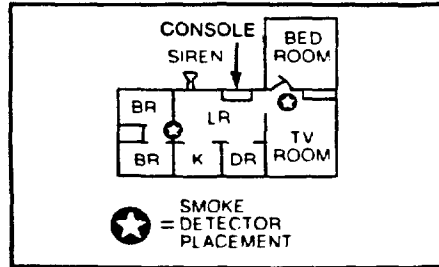

PLACE
DETECTOR
NEAR ALL
SLEEPING
AREAS

MAXIMUM FLOOR
COVERAGE—
DETECTORS AT
TOP OF
STAIRWELLS

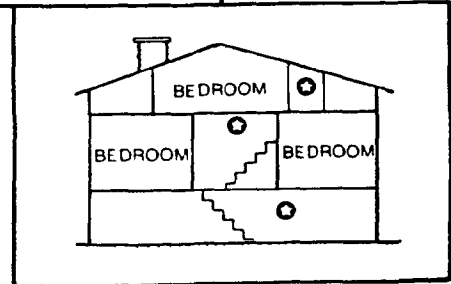

EMERGENCY EVACUATION

Every family should take steps to establish and regularly practice a plan of escape in the event of a fire. The following steps are recommended by the National Fire Protection Association and can be used as a guide in developing your own emergency plan.

1. Plan on your detector or your interior and/or exterior sounders waking the family.
2. Determine two means of escape from each room in your home, particularly the bedrooms, since most home fires occur at night when everyone is asleep. One path of escape should lead to the door that permits normal exit from the house. The other may be a window which opens easily to permit escape should your primary path be unpassable. It may be necessary to station an escape ladder at such windows if there is an unusually long drop to ground below.
3. Sketch a floor plan of your home. Show windows, doors, stairs and rooftops that can be used to escape in the event of fire.

Indicate escape routes for each room. Remember to keep these routes free from obstruction and post copies of the escape route sketch in every room.

4. Make sure that all bedroom doors are shut while the family is asleep. This will prevent deadly smoke from entering while you escape.
5. Try the door. If it is hot, check your alternate escape route. If the door is cool, use your shoulder to open it cautiously. Be prepared to slam the door if smoke or heat rushes in.
6. Crawl in the smoke and hold your breath.
7. Escape quickly; don't panic.
8. Establish a common meeting place outdoors, away from your house where everyone can meet and then take steps to contact the authorities and account for those missing. Choose someone to assure that nobody returns to the house — many die going back.

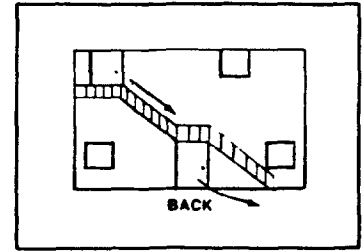
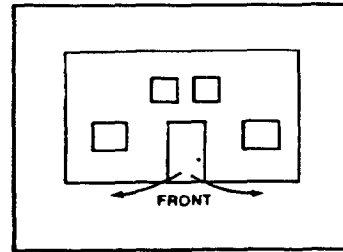
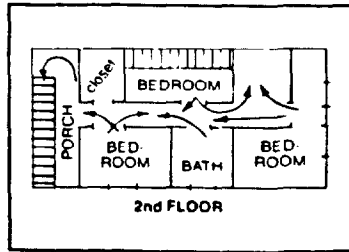
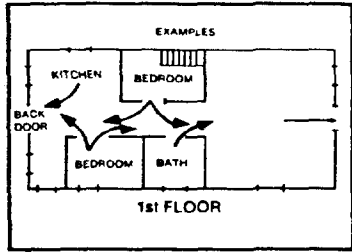

OWNER'S INSURANCE PREMIUM CREDIT REQUEST

This form should be completed and forwarded to your homeowner's insurance carrier for possible premium credit.

A. GENERAL INFORMATION:

Insured's Name and Address: _____

Insurance Company: _____ Policy No.: _____

Ademco VISTA SECURITY SYSTEM

Type of Alarm: Burglary Fire Both

Installed by: _____	Serviced by: _____
Name	Name
_____	_____
Address	Address

B. NOTIFIES (Insert B=Burglary, F=Fire)

Local Sounding Device: _____ Police Dept.: _____ Fire Dept.: _____

Central Station: _____ Name and Address: _____

C. POWERED BY: A.C. With Rechargeable Power Supply

D. TESTING: Quarterly Monthly Weekly Other _____

E. SMOKE DETECTOR LOCATIONS

Furnace Room _____ ,Kitchen _____ ,Bedrooms _____ ,Attic _____ ,
Basement _____ ,Living Room _____ ,Dining Room _____ ,Hall _____

F. BURGLARY DETECTING DEVICE LOCATIONS:

- Front Door Basement Door Rear Door All Exterior Doors
- 1st Floor Windows All Windows Interior Locations
- All Accessible Openings, Including Skylights, Air Conditioners and Vents

G. ADDITIONAL PERTINENT INFORMATION:

Signature: _____ Date: _____

ALARM DEVICE MANUFACTURING COMPANY
165 Eileen Way, Syosset, New York 11791

DRAW YOUR OWN EVACUATION PLAN

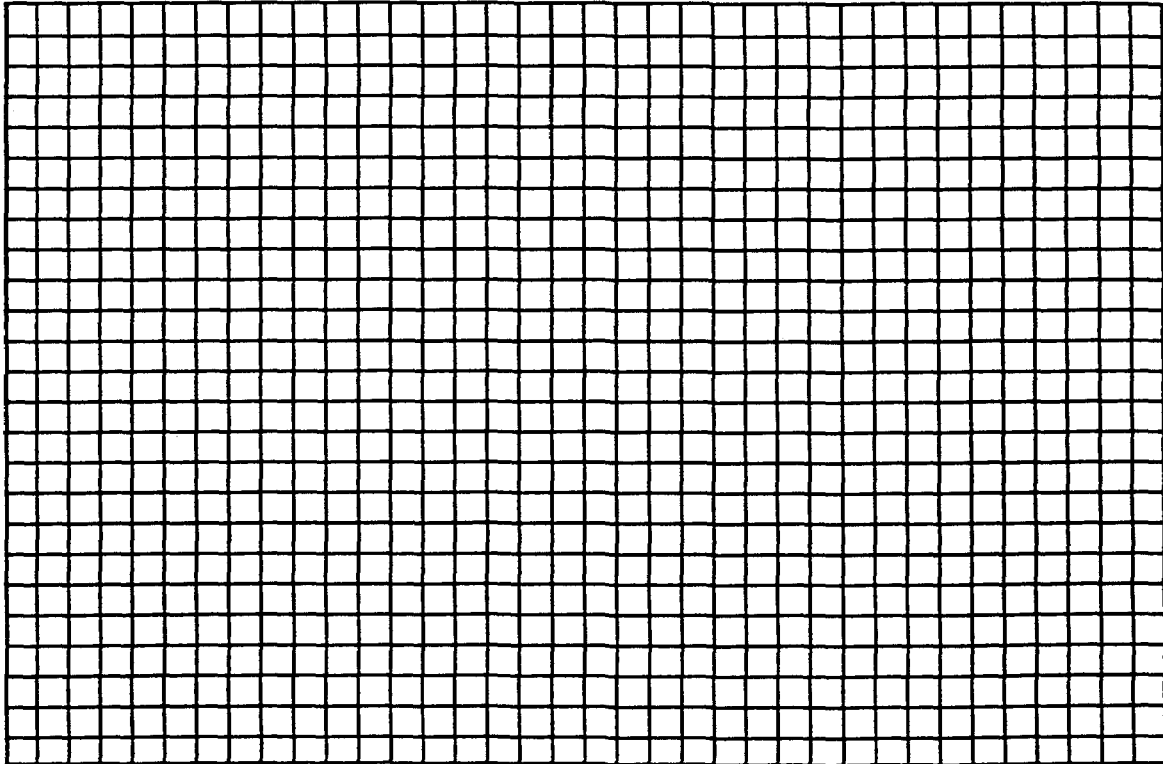

WARNING
THE LIMITATIONS OF THIS ALARM SYSTEM

While this system is an advanced design security system, it does not offer guaranteed protection against burglary or fire or other emergency. Any alarm system, whether commercial or residential, is subject to compromise or failure to warn for a variety of reasons. For example:

- Intruders may gain access through unprotected openings or have the technical sophistication to bypass an alarm sensor or disconnect an alarm warning device.
- Intrusion detectors (e.g., passive infrared detectors), smoke detectors, and many other sensing devices will not work without power. Battery operated devices will not work without batteries, with dead batteries, or if the batteries are not put in properly. Devices powered solely by AC will not work if their AC power supply is cut off for any reason, however briefly.
- A user may not be able to reach a panic or emergency button quickly enough.
- While smoke detectors have played a key role in reducing residential fire deaths in the United States, they may not activate or provide early warning for a variety of reasons in as many as 35% of all fires, according to data published by the Federal Emergency Management Agency. Some of the reasons smoke detectors used in conjunction with this System may not work are as follows. Smoke detectors may have been improperly installed and positioned. Smoke detectors may not sense fires that start where smoke cannot reach the detectors, such as in chimneys, in walls, or roofs, or on the other side of closed doors. Smoke detectors also may not sense a fire on another level of a residence or building. A second floor detector, for example, may not sense a first floor or basement fire. Moreover, smoke detectors have sensing limitations. No smoke detector can sense every kind of fire every time. In general, detectors may not always warn about fires caused by carelessness and safety hazards like smoking in bed, violent explosions, escaping gas, improper storage of flammable materials, overloaded electrical circuits, children playing with matches, or arson. Depending on the nature of the fire and/or the locations of the smoke detectors, the detector, even if it operates as anticipated, may not provide sufficient warning to allow all occupants to escape in time to prevent injury or death.

- Passive Infrared Motion Detectors can only detect intrusion within the designed ranges as diagrammed in their installation manual. Passive Infrared Detectors do not provide volumetric area protection. They do create multiple beams of protection, and intrusion can only be detected in unobstructed areas covered by those beams. They cannot detect motion or intrusion that takes place behind walls, ceilings, floors, closed doors, glass partitions, glass doors, or windows. Mechanical tampering, masking, painting or spraying of any material on the mirrors, windows or any part of the optical system can reduce their detection ability. Passive Infrared Detectors sense changes in temperature; however, as the ambient temperature of the protected area approaches the temperature range of 90° to 150°F, the detection performance can decrease.
- Alarm warning devices such as sirens, bells or horns may not alert people or wake up sleepers if they are located on the other side of closed or partly open doors. If warning devices sound on a different level of the residence from the bedrooms, then they are less likely to waken or alert people inside the bedrooms. Even persons who are awake may not hear the warning if the alarm is muffled from a stereo, radio, air conditioner or other appliance, or by passing traffic. Finally, alarm warning devices, however loud, may not warn hearing-impaired people or waken deep sleepers.
- Telephone lines needed to transmit alarm signals from a premises to a central monitoring station may be out of service or temporarily out of service. Telephone lines are also subject to compromise by sophisticated intruders.
- Even if the system responds to the emergency as intended, however, occupants may have insufficient time to protect themselves from the emergency situation. In the case of a monitored alarm system, authorities may not respond appropriately.
- This equipment, like other electrical devices, is subject to component failure. Even though this equipment is designed to last as long as 10 years, the electronic components could fail at any time.

The most common cause of an alarm system not functioning when an intrusion or fire occurs is inadequate maintenance. This alarm system should be tested weekly to make sure all sensors are working properly.

Installing an alarm system may make one eligible for lower insurance rates, but an alarm system is not a substitute for insurance. Homeowners, property owners and renters should continue to act prudently in protecting themselves and continue to insure their lives and property.

We continue to develop new and improved protection devices. Users of alarm systems owe it to themselves and their loved ones to learn about these developments.

ADEMCO ONE YEAR LIMITED WARRANTY

Alarm Device Manufacturing Company, a Division of Pittway Corporation ("Seller"), 165 Eileen Way, Syosset, New York 11791, warrants its security equipment (the "product") to be free from defects in materials and workmanship for one year from date of original purchase, under normal use and service. Seller's obligation is limited to repairing or replacing, at its option, free of charge for parts, labor, or transportation, any part proven to be defective in materials or workmanship under normal use and service. Seller shall have no obligation under this warranty or otherwise if the product is altered or improperly repaired or serviced by anyone other than the Seller. In case of defect, contact the security professional who installed and maintains your security system or the Seller for product repair.

This one year Limited Warranty is in lieu of all other express warranties, obligations or liabilities. THERE ARE NO EXPRESS WARRANTIES WHICH EXTEND BEYOND THE FACE HEREOF. ALL IMPLIED WARRANTIES, OBLIGATIONS OR LIABILITIES MADE BY SELLER IN CONNECTION WITH THIS PRODUCT, INCLUDING ANY IMPLIED WARRANTY OF MERCHANTABILITY, OR FITNESS FOR A PARTICULAR PURPOSE OR OTHERWISE, ARE LIMITED IN DURATION TO A PERIOD OF ONE YEAR FROM THE DATE OF ORIGINAL PURCHASE. ANY ACTION FOR BREACH OF ANY WARRANTY, INCLUDING BUT NOT LIMITED TO ANY IMPLIED WARRANTY OF MERCHANTABILITY, MUST BE BROUGHT WITHIN 18 MONTHS FROM DATE OF ORIGINAL PURCHASE. IN NO CASE SHALL SELLER BE LIABLE TO ANYONE FOR ANY CONSEQUENTIAL OR INCIDENTAL DAMAGES FOR BREACH OF THIS OR ANY OTHER WARRANTY, EXPRESS OR IMPLIED, OR UPON ANY OTHER BASIS OF LIABILITY WHATSOEVER, EVEN IF THE LOSS OR DAMAGE IS CAUSED BY THE SELLER'S OWN NEGLIGENCE OR FAULT. Some states do not allow limitations on how long an implied warranty lasts or the exclusion or limitation of incidental or consequential damages, so the above limitation or exclusion may not apply to you.

Seller does not represent that the product may not be compromised or circumvented; that the product will prevent any personal injury or property loss by burglary, robbery, fire or otherwise; or that the product will in all cases provide adequate warning or protection. Buyer understands that a properly installed and maintained alarm may only reduce the risk of a burglary, robbery or fire occurring without providing an alarm, but it is not insurance or a guarantee that such will not occur or that there will be no personal injury or property loss as a result. CONSEQUENTLY, SELLER SHALL HAVE NO LIABILITY FOR ANY PERSONAL INJURY, PROPERTY DAMAGE OR OTHER LOSS BASED ON A CLAIM THE PRODUCT FAILED TO GIVE WARNING. However, if Seller is held liable, whether directly or indirectly, for any loss or damage arising under this Limited Warranty or otherwise, regardless of cause or origin, Seller's maximum liability shall be the complete and exclusive remedy against Seller. This warranty gives you specific legal rights, and you may also have other rights which vary from state to state. No increase or alteration, written or verbal, to this warranty is authorized.

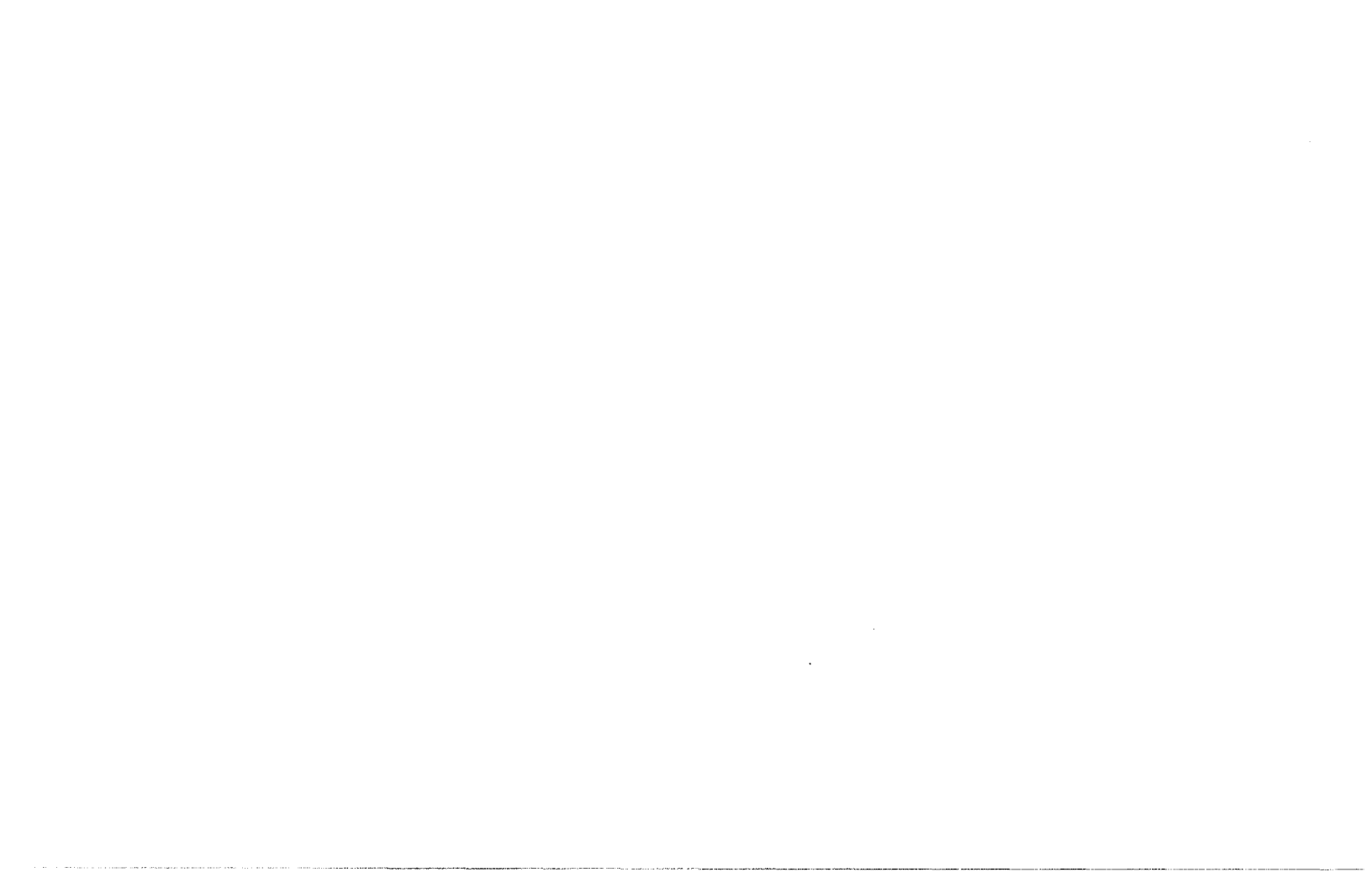



A DIVISION OF PITTMAY CORPORATION

N4411 9/88

Copyright © 1988 PITTMAY CORPORATION